

1.1 Ringtypen

Die verschiedenen Ausführungen der Kolbenringe und die im Katalog angewendeten Kurzzeichen sind

nachfolgend aufgeführt. Die einzelnen Ringe werden wie unten aufgezichnet (siehe auch 4. Einbau von

Ringen – Schritt für Schritt) auf den Kolben montiert.

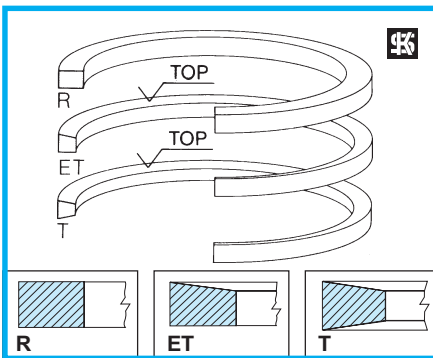

R Rechteckring
ET einseitiger Trapezring
T Trapezring 6° / 15°

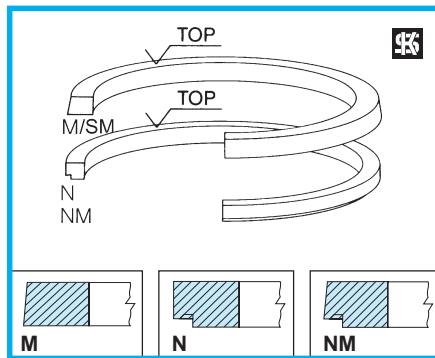

M Minutenring
SM Schwachminutenring
N Nasenring
NM Nasenminutenring

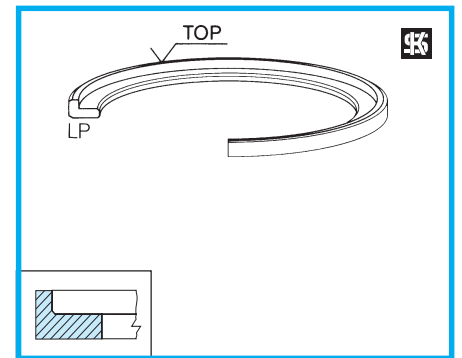

LP L-Profilring

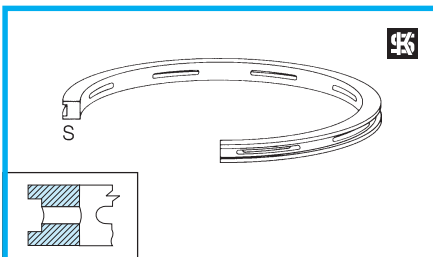

S Ölschlitzring

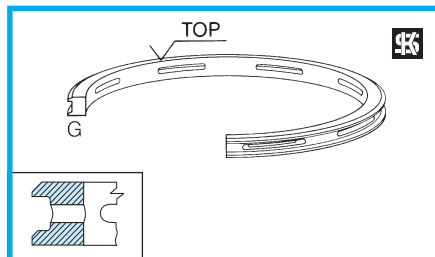

G Gleichfaserring

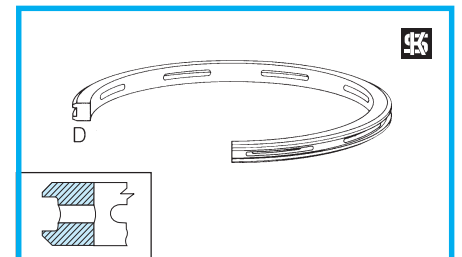

D Dachfaserring

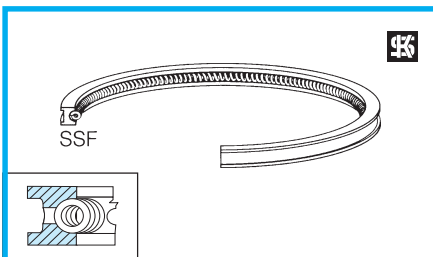

SSF Ölschlitz-Schlauchfederring

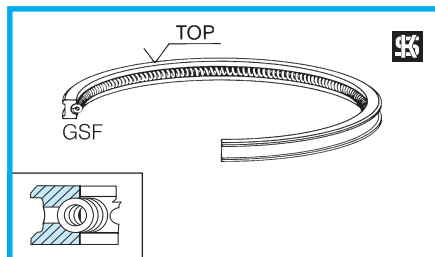

GSF Gleichfasen-Schlauchfederring

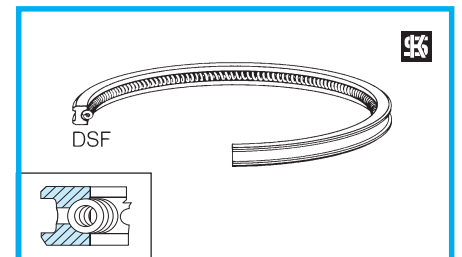

DSF Dachfasen-Schlauchfederring

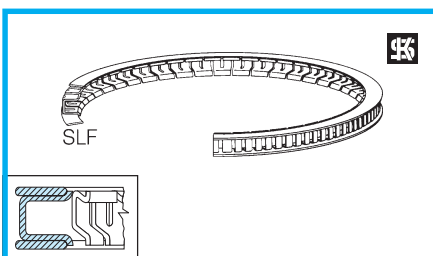

SLF Stahllamellen-Ölring

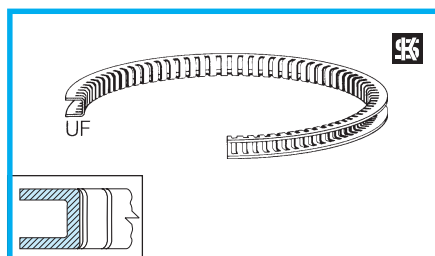

UF U-Flex-Ring

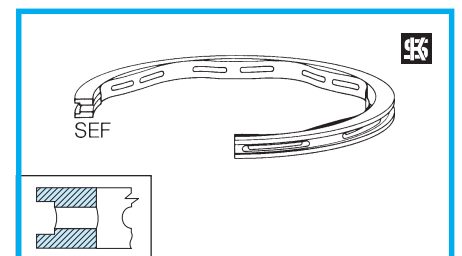

SEF Ölschlitzring mit Expanderfeder

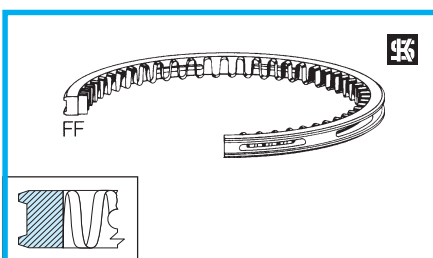

FF Formflex-Ring

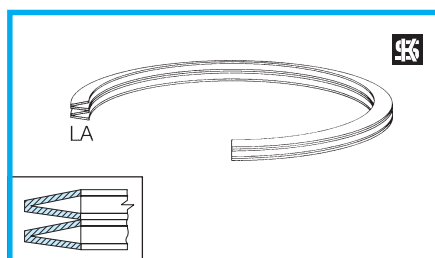

LA Lamellenring